

# 1951™

Progressions



## Specification Guide 2025

# Beautifully Budget Friendly

Elevate the look of any space without going over budget. Our Progressions Cabinetry line features two distinct cabinet styles, complemented by three durable finishes.

Our **Cody cabinets** bring style and versatility to any room. These Shaker door styles come in a bright, versatile white that allows for endless design possibilities or a warm, earthy pebble color that creates a cozy, sophisticated vibe. You can also get creative and mix and match both colors for a personalized touch. Both are made of durable Thermofoil, which offers consistent color and resists chipping and cracking.

**Garrett cabinets** are crafted from high-quality hardwood. Finished in a rich umber shade that highlights the natural beauty of the wood grain, their classic Shaker style brings warmth and charm to any space. Pair them with a light, earthy backsplash in soft shades of green, orange, or yellow for a pop of color to add a touch of visual interest.

## What's New for 2025

From additional wall and base cabinet expansions to tall cabinets and an expanded cabinet line, discover all the new enhancements to our cabinetry line. Also, look for our parts directory at the back of this guide. If you have any questions, contact our Partner Team at 1-877-957-7278.

For easy identification, we've highlighted the new offerings.



### Wall Cabinet Expansion

W3015 BUTT, W3615 BUTT, W3612X24 BUTT, W3618X24 BUTT, W3624X24 BUTT

### Base Cabinet Expansion

DSB36 BUTT, BLB39/45

### Accessible Sink Base

ASB36 BUTT

### Tall Cabinets

UT1884X24DP AS, UT1890X24DP AS, UT1896X24DP AS

### Base Waste Basket Redesign

BWBB18-2

### Hardware Expansion

KNOB 1173 and PULL 1701 are now also available in Matte Black, Modern Brushed Gold, and Polished Chrome

### Discontinuations

PULL 1708SN

*In keeping with our policy of continuous product refinement, 1951 Cabinetry reserves the right to change specifications in design and materials as conditions require.*

# Table of Contents

## Door Styles & Cabinet Construction

Cody.....	4
Garrett .....	5
Cabinet Materials .....	6
Cabinet Opening Dimensions.....	6
Cabinet Construction.....	7
Cabinet Overlay Dimensions .....	8

## Product Specifications

Wall Cabinets.....	10
Base Cabinets .....	11
Vanity Cabinets .....	12
Tall Cabinets.....	13
Accessory Items.....	13
Molding.....	16
Hardware .....	17
Important Information.....	18



ANSI/KCMA A161.1



KITCHEN CABINET MANUFACTURERS ASSOCIATION  
ENVIRONMENTAL STEWARDSHIP PROGRAM (ESP)  
ALL PRODUCTS IMPACT THE ENVIRONMENT.  
FOR ESP PROGRAM DETAILS, VISIT 1951PROG.COM

All cabinetry manufactured by 1951 Progressions is certified by the Kitchen Cabinet Manufacturers Association (KCMA).

1951 Progressions has received certification by KCMA Environmental Stewardship Program on all products.



# Door Styles & Cabinet Construction

The 1951 Progressions collection presents a choice of two shaker door designs available in three popular finishes—White, Pebble, and Umber—blending style and affordability.

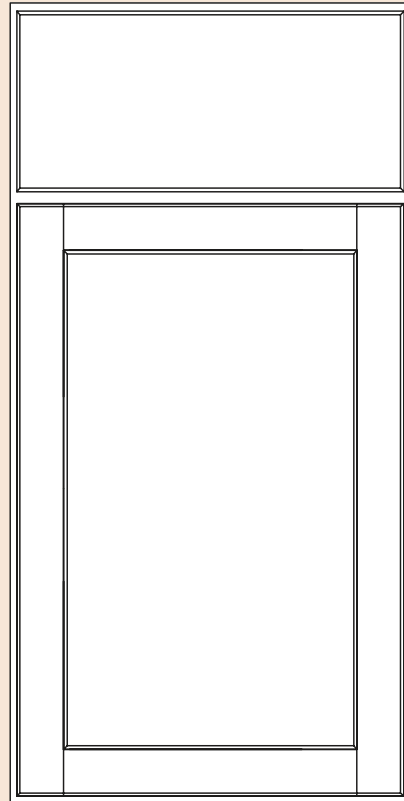
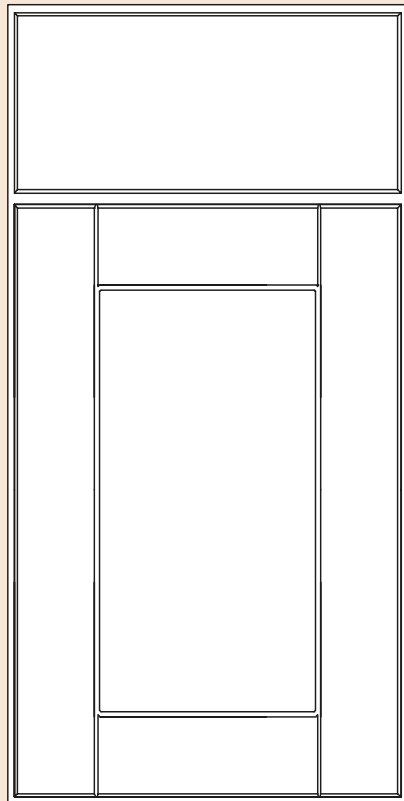

# Cody

DOOR STYLE

Cody White has a remarkable impact on any living space, with its pure and pristine quality. It makes any room appear larger and more inviting, saturating its environment with a sense of spaciousness and airiness. White is timeless and elegant, providing a blank canvas that harmonizes effortlessly with various design styles and color schemes. Its clean and bright aesthetic fosters a sense of serenity and freshness, especially in spaces such as kitchens. White is a versatile choice that allows for creativity and personalization, whether through contrasting accents or a minimalist, contemporary vibe.

Cody Pebble is a fusion of warm brown and subtle gray, creating a unique and versatile aesthetic. The result is a rich, earthy hue that emanates a sense of comfort and sophistication. This finish strikes a harmonious balance between traditional and contemporary design, making it an ideal option for a variety of decor styles.

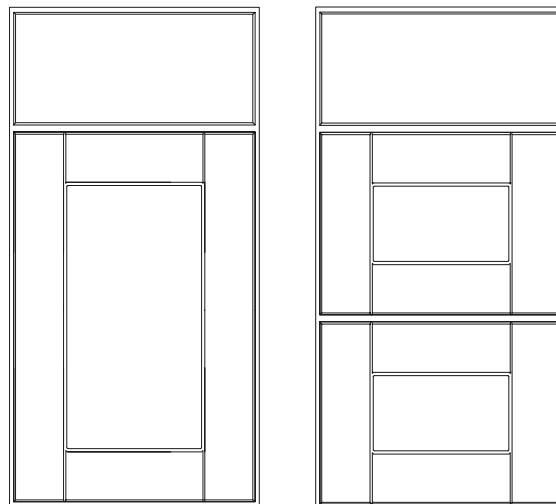

— 2" —

Finish	Code
--------	------

White	1SSW
-------	------

Pebble	1SDV
--------	------

## Features

### Construction

Routed MDF with Recessed Panel

### Door Details

Full Overlay

### Material

Thermofoil

### Hardware

Required



# Garret

## DOOR STYLE

Umber gives a timeless elegance and warmth. It highlights the natural beauty of wood through its deep, earthy tones that convey a sense of authenticity and comfort. The intricate patterns and texture create a rich tactile and visual experience, making any space feel welcoming and cozy. Umber not only offers a classic and enduring appeal but also adds a touch of luxury.

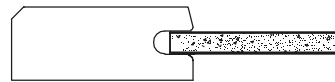
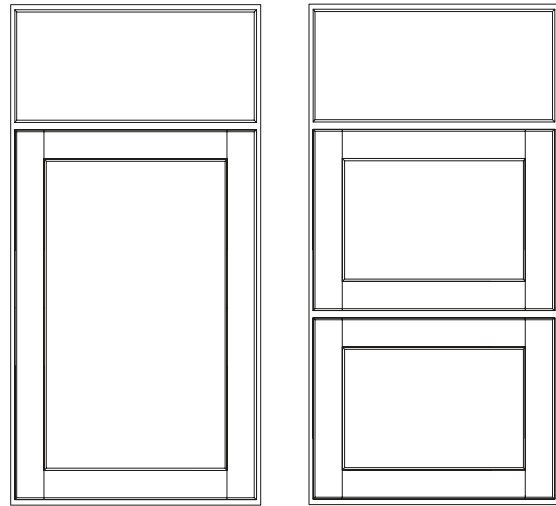

— 2" —

Finish	Code
--------	------

Umber	1SJM
-------	------

## Features

### Construction

Mortise & Tenon

### Door Details

Full Overlay

### Material

Hardwood

### Hardware

Required

# Choosing Your Material

## Hardwood

Hardwood cabinetry has a dense structure and comes from a combination of deciduous trees such as maple, beech, birch, or poplar. Natural colors range from light blonde to dark reddish-brown tones. These hardwoods may contain mineral streaks, slight differences in graining, and color variations.

## Thermofoil

Thermofoil is a process whereby a thick vinyl film is bonded permanently to a warp-resistant engineered wood core. Because the color is consistent throughout the film, the surface is durable, easy to clean, and resistant to chipping and cracking.

# Cabinet Opening Dimensions

Illustrations specify dimensions of vertical stiles and horizontal rails, inset toe kick, and standard interior opening heights. When selecting cabinetry for installation above or near any appliance, refer to the appliance manufacturer's specification for clearance and venting requirements.

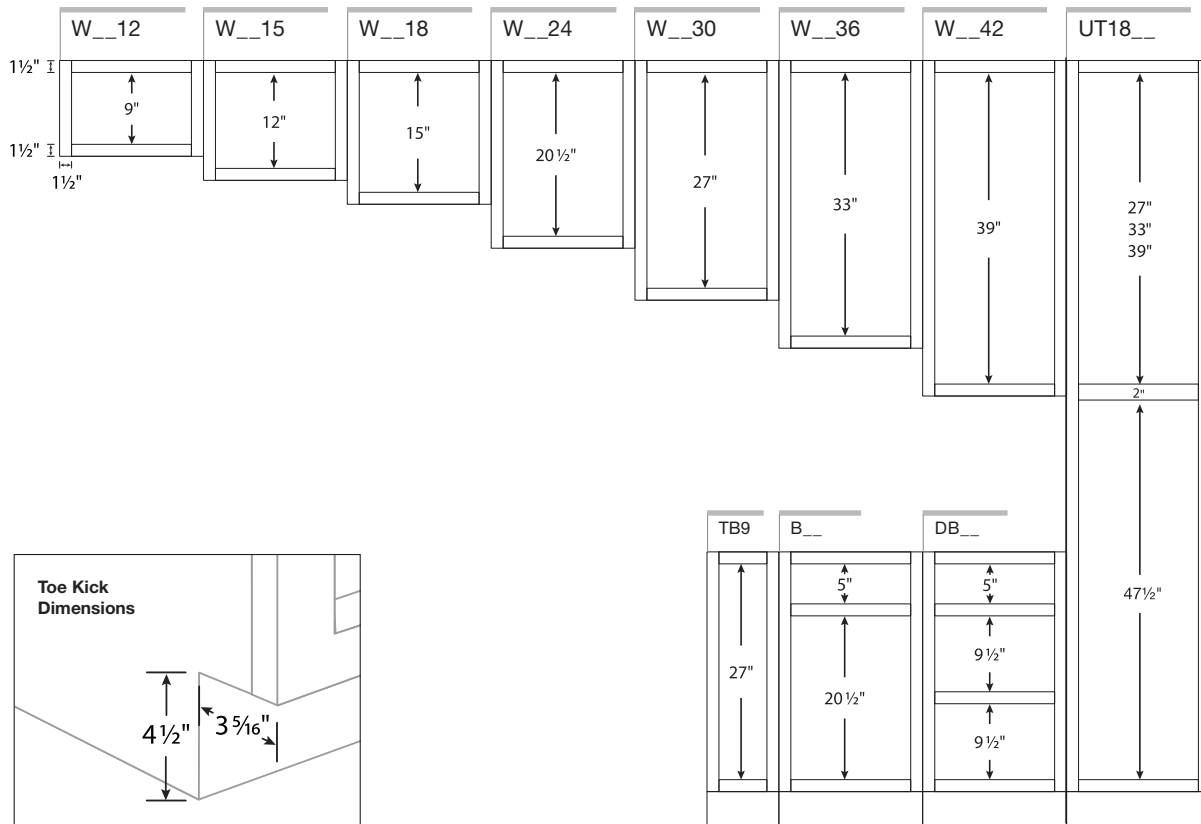



# Cabinet Construction

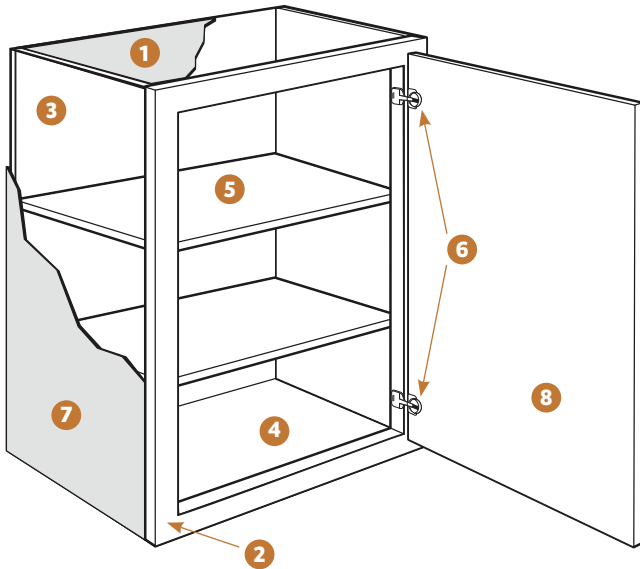

## Wall Cabinets

- 1 **Top/Bottom Panels:**  $\frac{3}{8}$ " engineered wood
- 2 **Face Frame:** 1  $\frac{1}{2}$ " wide frame material
- 3 **Back Panel:** Full  $\frac{3}{8}$ " back panel
- 4 **Interiors:** Natural wood-grain laminate finish on engineered wood
- 5 **Shelves:**  $\frac{3}{4}$ " thick adjustable shelves
- 6 **Hinges:** Fully concealed and adjustable
- 7 **End Panels:**  $\frac{1}{2}$ " engineered wood with laminated exterior to match cabinet finish
- 8 **Door:** Reversible door on single-door cabinets for left or right opening; hinged on the left from the factory; double-door cabinets are butt doors with no center stile

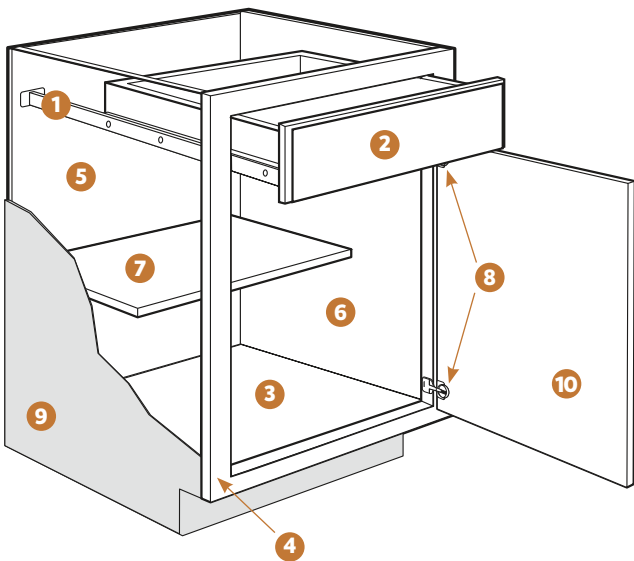

## Base Cabinets

- 1 **Drawer Glides:**  $\frac{3}{4}$ " access ball bearing
- 2 **Drawer Box:** Hardwood, 4-sided drawer box with fully encapsulated bottom
- 3 **Bottom Panels:**  $\frac{3}{8}$ " engineered wood
- 4 **Face Frame:** 1  $\frac{1}{2}$ " wide frame material
- 5 **Back Panel:** Full  $\frac{3}{8}$ " back panel with a natural laminate interior
- 6 **Interiors:** Natural wood-grain laminate finish on engineered wood
- 7 **Shelf:**  $\frac{3}{4}$ " thick adjustable half-depth shelf
- 8 **Hinges:** Fully concealed and adjustable
- 9 **End Panels:**  $\frac{1}{2}$ " engineered wood with laminated exterior to match cabinet finish
- 10 **Door:** Reversible door on single-door cabinets for left or right opening; hinged on the left from the factory; double-door cabinets are butt doors with no center stile

# Cabinet Overlay Dimensions

## Full Overlay

Full overlay doors are sized to cover nearly all of the cabinet face frame. Full overlay door styles require decorative hardware. To facilitate proper door operation, include at least a 1" filler between the hinged side of full overlay door styles and deeper adjacent objects including cabinets, walls, appliances, and countertops.

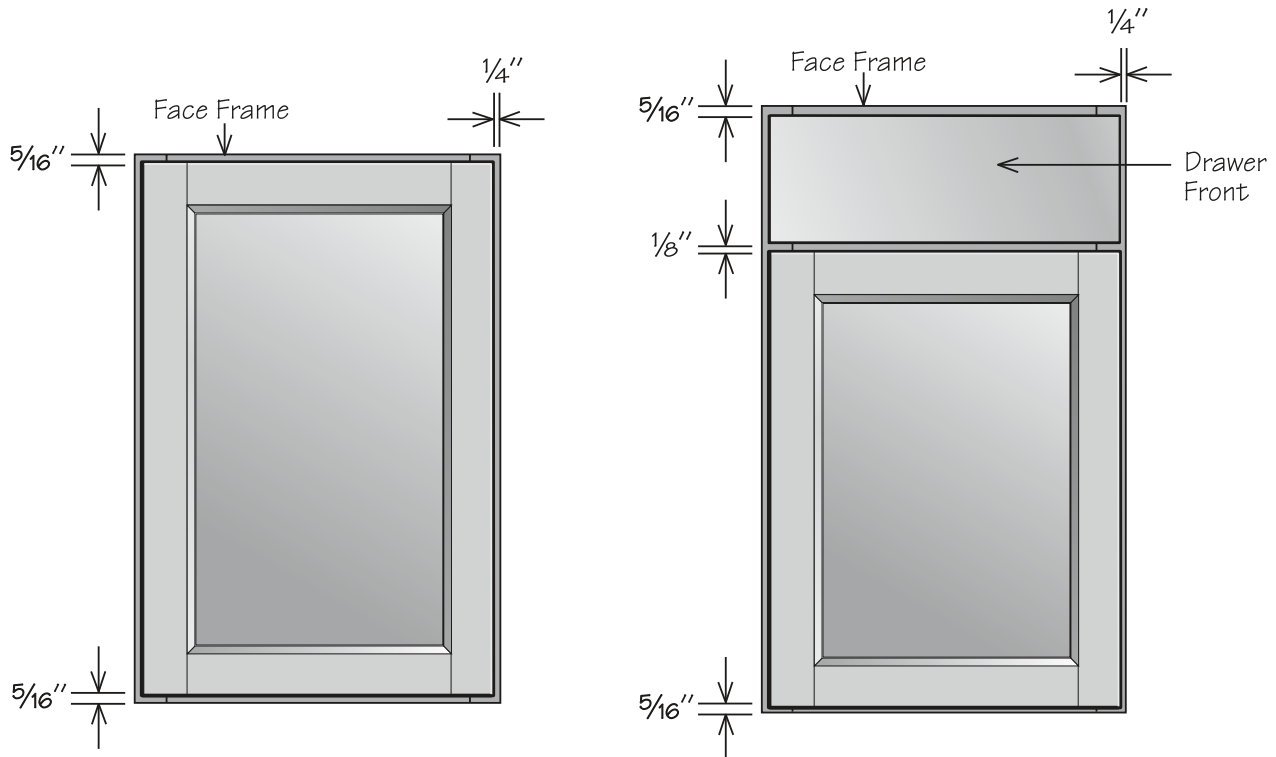

# Product Specs

Create the kitchen that perfectly fits your lifestyle. You'll find the quality construction and features at prices that help you get the most kitchen for your budget—and years of enjoyment.

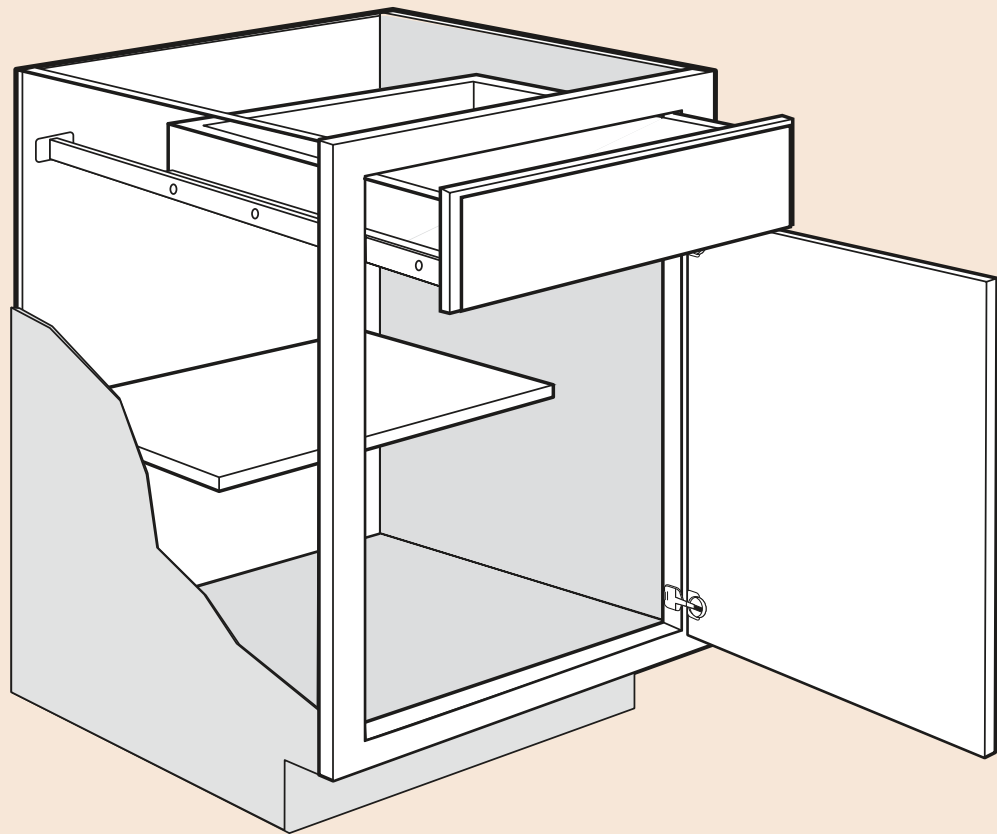

# Wall Cabinet Specifications

## Wall Cabinet | 1 Door

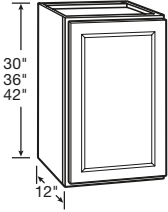

- Includes two adjustable shelves
- Hinged left, field reversible

30" HIGH	36" HIGH	42" HIGH
W1230	W1236	W1242
W1530	W1536	W1542
W1830	W1836	W1842
W2130	W2136	W2142
W2430	W2436	W2442

## Refrigerator Wall Cabinet | 2 Butt Doors

**NEW!** SIZES

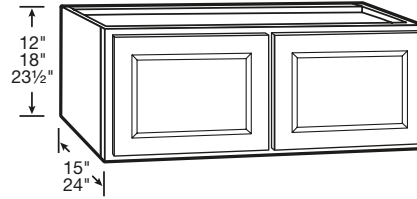

- Includes one adjustable shelf

12" HIGH • No Shelf	18" HIGH • No Shelf	24" HIGH • 1 Shelf
<b>24" Deep</b>	<b>24" Deep</b>	<b>24" Deep</b>
W3612X24DP BUTT	W3618X24DP BUTT	W3624X24DP BUTT
		<b>15" Deep</b>
		W3024X15DP BUTT

## Wall Cabinet | 2 Butt Doors **NEW!** SIZES

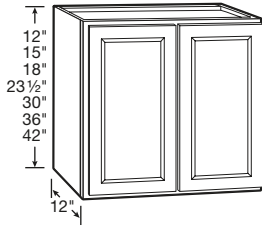

12" HIGH • No Shelf	15" HIGH • No Shelf	18" HIGH • No Shelf
W3012 BUTT	W3015 BUTT	W3018 BUTT
W3612 BUTT	W3615 BUTT	W3618 BUTT
24" HIGH • 1 Shelf	30" HIGH • 2 Shelves	36" HIGH • 2 Shelves
W3024 BUTT	W2730 BUTT	W2736 BUTT
W3624 BUTT	W3030 BUTT	W3036 BUTT
	W3330 BUTT	W3336 BUTT
	W3630 BUTT	W3636 BUTT
42" HIGH • 2 Shelves		
W2742 BUTT		
W3042 BUTT		
W3342 BUTT		
W3642 BUTT		

## Corner Wall Cabinet

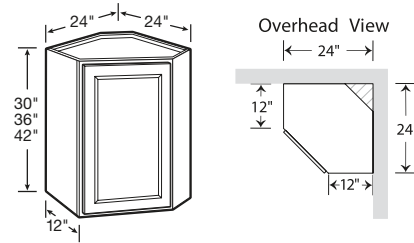

- Installs in a 24" x 24" wall area
- 30" high includes one adjustable shelf
- 36" high and 42" high include two adjustable shelves
- Hinged left, field reversible

30" HIGH	36" HIGH	42" HIGH
CW2430	CW2436	CW2442

# Base Cabinet Specifications

## Full-Height Base Cabinet | 1 Door

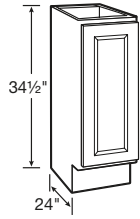

- One half-depth adjustable shelf included
- Hinged left, field reversible

**34½" HIGH**

TB9

## Base Cabinet | 1 Door and 1 Drawer

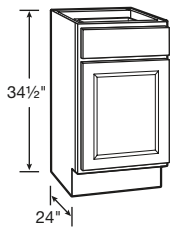

- Ball-bearing drawer glides
- One half-depth adjustable shelf included
- Hinged left, field reversible

**34½" HIGH**

B12	B21
B15	B24
B18	

## Base Cabinet | 2 Butt Doors and 1 Drawer

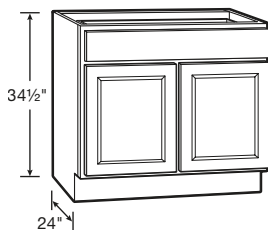

- Ball-bearing drawer glides
- One half-depth adjustable shelf included

**34½" HIGH**

B27 BUTT  
B30 BUTT  
B33 BUTT  
B36 1TD BUTT

## Base Cabinet | 1 Door with Wastebasket Pull-Out and 1 Drawer

**NEW! PRODUCT**

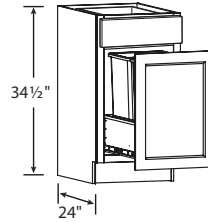

- Top drawer includes ball-bearing drawer glides
- Wastebasket pullout includes heavy-duty ball-bearing drawer glides and two 35-quart capacity bins

**34½" HIGH**

BWBB18-2

## Drawer Base Cabinet | 3 Drawers

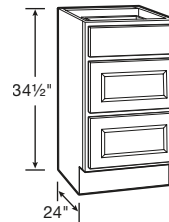

- 18" wide and 24" wide include ball-bearing drawer glides
- 30" wide and 36" wide include full-extension, heavy-duty drawer glides on all three drawers
- Deep drawers feature five-piece drawer fronts

**34½" HIGH**

DB18	DB30
DB24	DB36 1TD

## Sink/Cooktop Base | 2 Butt Doors and 1 Panel

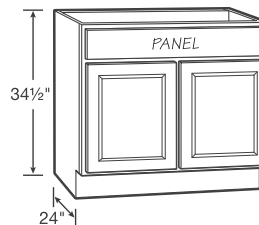

- Full-height back panel
- No shelf
- Subtract 1½" from width and 1" from depth for available sink bowl opening
- Refer to sink/cooktop manufacturer's specifications for adequate clearance and required installation materials
- Touch-up kit included

**34½" HIGH**

SB30 BUTT TU  
SB36 BUTT TU

# Base Cabinet Specifications

## Corner Base Carousel | Spin Unit

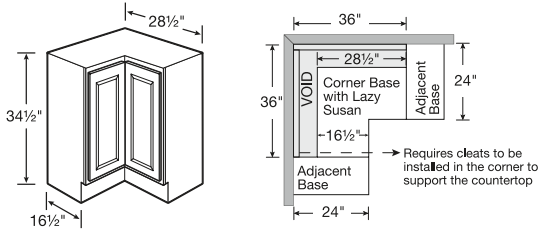

- Installs in a 36" x 36" wall area
- Two-piece overlay door hinged together in the middle
- Two 360° independently rotating metal racks
- Exterior side panels are natural laminate
- Hinged left, reversible in field
- Additional space recommended if appliance is installed on the hinged side of this cabinet for proper door operation
- If unit has an exposed side, order an end panel separately

**34 1/2" HIGH**

CAR36

## Blind Base Cabinet NEW! PRODUCT

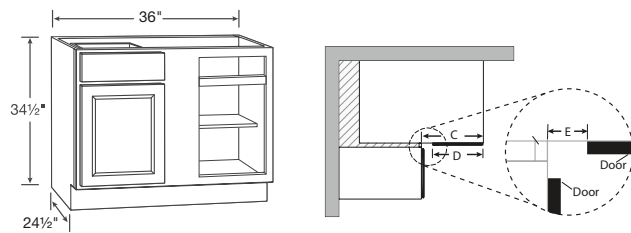

**BLIND CABINET DIMENSIONS**

OVERLAY	OVERLAY	WALL SPACE		EXPOSED FRAME C*	DOOR WIDTH D	EXPOSED STILE E*
		MAX B	MAX B			
OVERLAY	36"	46 1/2"	40 1/8"	18"	14 3/4"	3 1/8"

- Includes one half-depth adjustable shelf
- Door and drawer are reversible to accommodate left or right blind

**34 1/2" HIGH**

BLB39/45

## Deep Sink Base NEW! PRODUCT

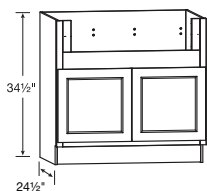

**APRON CUTOUT DIMENSIONS**

ACTUAL WIDTH	MAX. WIDTH	ACTUAL HEIGHT	MAX. HEIGHT
29"	33"	7 1/2"	11"

- 2" stiles and 4" rail are trimmable to accommodate various size sinks/cooktops
- Smaller size sinks/cooktops can be accommodated with use of 3" or 6" filler
- No shelf

**34 1/2" HIGH**

DSB36 BUTT

## Accessible Sink Base NEW! PRODUCT

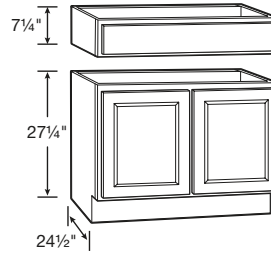

- Exterior side panels are natural maple laminate
- Features one false drawer front on detachable cabinet header
- No shelf

**34 1/2" HIGH**

ASB36 BUTT

# Vanity Cabinet Specifications

## Vanity Drawer Base | 3 Drawers

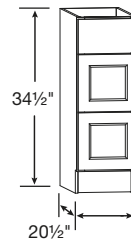

- Deep drawers feature five-piece drawer fronts

**34 1/2" HIGH**

VDB1234H

VDB1534H

VDB1834H

## Vanity Sink Base | 2 Butt Doors and 1 Drawer Panel

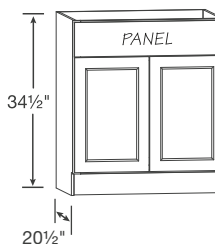

- No shelf
- Subtract 1 1/2" from width and 1 1/2" from depth for available sink bowl opening
- Refer to sink manufacturer's specifications for adequate clearance and required installation materials

**34 1/2" HIGH**

VSB2434H BUTT

VSB2734H BUTT

VSB3034H BUTT

VSB3334H BUTT

VSB3634H BUTT

## Tall Cabinet Specifications

### Pantry Cabinet | 24" Deep NEW! PRODUCT

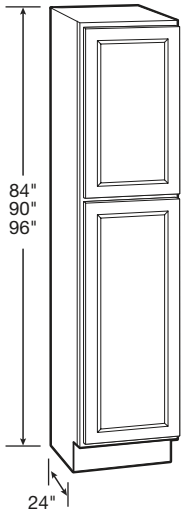

- Upper door lines up with 30", 36" and 42" high wall cabinets
- 84" and 90" includes three full-depth adjustable shelves and one full-depth fixed shelf
- 96" includes four full-depth adjustable shelves and one full-depth fixed shelf
- 96" has removable toe kick that is field installed

84" HIGH	90" HIGH	96" HIGH
UT1824X84 AS	UT1824X90 AS	UT1824X96 AS

### Double Oven Cabinet | 2 Butt Doors and 1 Drawer

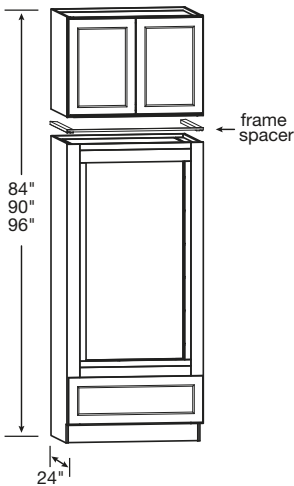

- Includes drawer with full-extension, heavy-duty drawer glides
- Includes 24" deep wall cabinet (ships separately)
- Overhead wall cabinet is not pre-installed to oven cabinet, comes as two pieces, boxed separately
- Rails and stiles around oven opening are trimmable
- Cut-out dimensions:
  - » Width: 24" minimum, 30" maximum
  - » Height: 47½" minimum, 52½" maximum
- Frame spacer included in OVD339624 BUTT only
- 96" high double oven overhead wall cabinet is 23½" high

84" HIGH	90" HIGH	96" HIGH
OVD338424 BUTT	OVD339024 BUTT	OVD339624 BUTT

## Accessory Item Specifications

### Veneer End Paneling

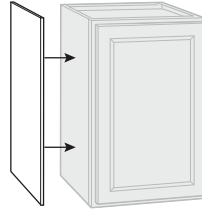

- Finished veneer panels fit flush
- Umber panels feature stained veneers
- White and Pebble panels are laminate
- Wall panels are 1¼" deep, 30" or 42" high
- Base panels are 23¼" deep x 34½" high
- Finished panel is 48" wide x 34½" high

WALL PANEL	BASE PANEL	FINISHED PANELING
WEP30 WEP42	BEP34	FP4834

### Wall & Base Fillers

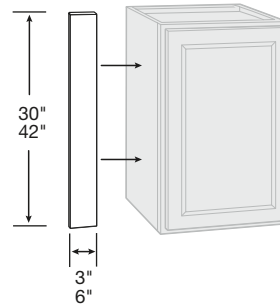

- ¾" thick
- Cody door styles feature wrapped-plywood finished on the face only
- Garrett door style features hardwood finished on the face only

3" FILLER	6" FILLER
UF3P UF342P	UF6P UF642P



# Accessory Item Specifications

## Tall Filler

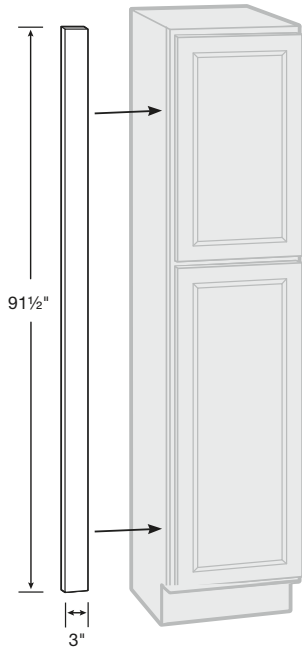

- 3/4" thick
- Cody door styles feature wrapped-plywood finished on the face only
- Garrett door style features hardwood finished on the face only

**91 1/2" HIGH**

UF392P

## Refrigerator Return Kit

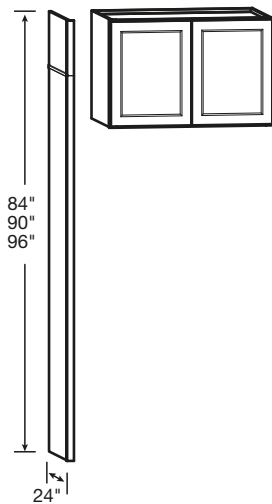

- Kit includes one 84" tall end panel, one 12" tall panel, one 6" tall panel, and one piece of scribe molding
- Kits and Wall Cabinets combine to achieve 84", 90", or 96" overall heights
- Pairs with 36" wide wall cabinets, sold separately—see Wall Cabinets section
- Refrigerator Return Kit does not create a stand-alone cabinet; must be anchored to other cabinets/wall studs to be secure

**96" HIGH**

RR96

## Dishwasher Return

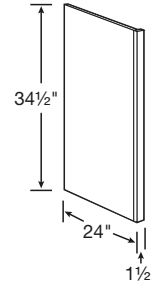

- Reversible for left or right installation
- Exterior finish to match
- Field trimmable to 1"
- Can be notched for toe kick in the field

**34 1/2" HIGH**

DWR1\_5

## Decorative Matching Doors

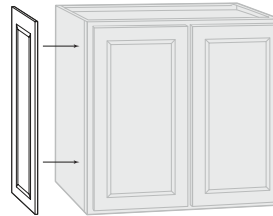

### WALL

**12" Deep**

DMDW30  
DMDW36  
DMDW42

**15" Deep**

DMDW30 15D

**18" Deep**

DMDW30 18D

### BASE

**24" Deep**

DMDB

## Finished Shelves

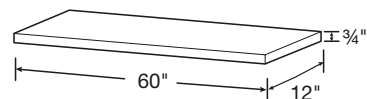
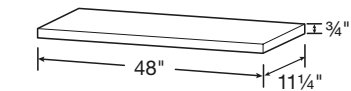

- 3/4" depth difference between shelf lengths
- Laminate finish on five sides

**48" WIDE**

**11 1/4" Deep**  
FS4812

**60" WIDE**

**12" Deep**  
FS6012

# Accessory Item Specifications

## Decorative Island End Panel Kit

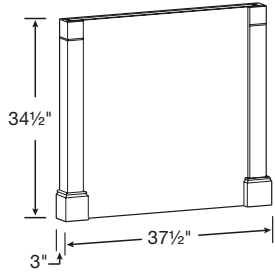

- One post ships loose
- Panel can be cut to accommodate different depths

**34 1/2" HIGH**

ISLAND PANEL KIT

## Sliding Shelf Kit

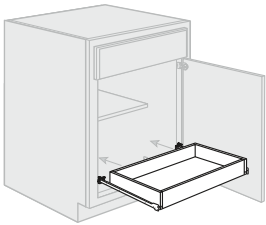

- Ball-bearing drawer glides
- Hardwood drawer box SSK24 fits in 24" wide base
- Hardwood drawer box SSK30 fits in 30" wide base
- Ready to assemble accessory kit requiring field installation
- Kit includes sliding shelf and all hardware

SSK24  
SSK30

## Countertop Corbel

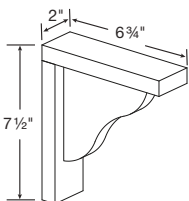

- For decorative use only

CS8

## Toe Kick

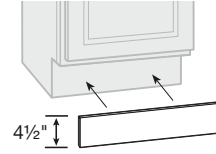

- 91 1/2" long

BTK8

## Cabinet Repair Material

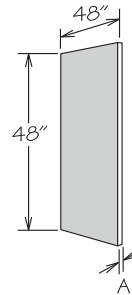

- Back features 3/16" MDF finished on one side with a natural woodgrain look
- Floor features 1/2" thick particleboard finished on both sides with a natural woodgrain look

BACK	A	FLOOR	A
BACK-W48X48	3/16"	FLOOR48X48	1/2"

## Cleats

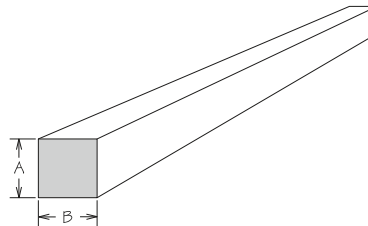

- Unfinished

	A	B	LENGTH
HWC 1/2X1/2X91.5	1/2"	1/2"	91 1/2"
HWC 3/4X3/4X91.5	3/4"	3/4"	91 1/2"
HWC 1X2X91.5	3/4"	1 1/2"	91 1/2"
HWC 2X4X91.5	1 1/2"	3 1/2"	91 1/2"

# Molding Specifications

## Crown Moldings

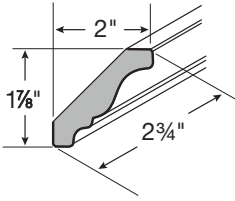

TRADITIONAL CROWN

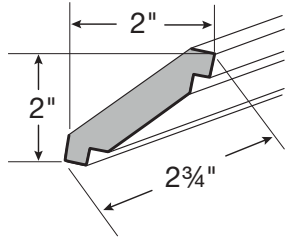

SHAKER CROWN

- 91½" long
- Bold line indicates finished surfaces

**TRADITIONAL CROWN**

CM8

**SHAKER CROWN**

ACM8

## Molding Stock

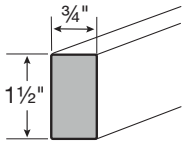

- 91½" long
- Bold line indicates finished surfaces

**SQUARE EDGE**

SS1\_596

## Light Rail Molding

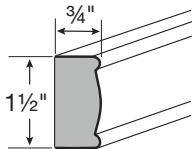

- 91½" long
- Bold line indicates finished surfaces

**DECORATIVE EDGE**

LBM8

## Base Molding

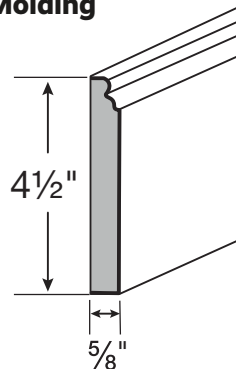

- 91½" long
- Bold line indicates finished surfaces

**BASE**

CLBM8

## Trim Molding

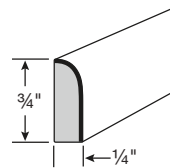

SCRIBE

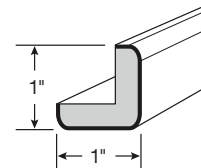

OUTSIDE CORNER

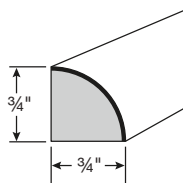

QUARTER ROUND

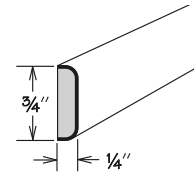

BATTEN

- 91½" long
- Bold line indicates finished surfaces

**SCRIBE**

SM8

**QUARTER ROUND**

SHM8

**OUTSIDE CORNER**

OCM8

**BATTEN**

BM8

# Hardware Specifications

---

## Classic Knob



**Classic Knob  
Polished Chrome**  
KNOB 1173PC

**NEW!** FINISH



**Classic Knob  
Satin Nickel**  
KNOB 1173SN



**Classic Knob  
Modern Brushed Gold**  
KNOB 1173MG

**NEW!** FINISH



**Classic Knob  
Matte Black**  
KNOB 1173MB

**NEW!** FINISH

---

## T-Bar Pull



**T-Bar Pull  
Polished Chrome**  
PULL 1701PC  
3" Center • Overall Length: 5"

**NEW!** FINISH



**T-Bar Pull  
Satin Nickel**  
PULL 1701SN  
3" Center • Overall Length: 5"



**T-Bar Pull  
Modern Brushed Gold**  
PULL 1701MG  
3" Center • Overall Length: 5"

**NEW!** FINISH



**T-Bar Pull  
Matte Black**  
PULL 1701MB  
3" Center • Overall Length: 5"

**NEW!** FINISH

## Important Information

### Lifetime Limited Warranty

The manufacturer of 1951 Progressions cabinetry warrants to the original residential or commercial purchaser that all 1951 Progressions cabinetry, cabinets, and accessories, are free from defects in materials and workmanship for the following durations, subject to the limitations set forth below:

Original residential purchaser: An "original residential purchaser" is defined as any person who purchases the cabinetry for personal use in his or her private residence. The duration of this limited warranty begins at the date of delivery to the residence and extends until such time as that residential purchaser no longer resides at the residence. "Residential purchaser" extends to any person who owns and resides in the residence where the cabinetry is installed, for whom the cabinetry is purchased by a contractor, remodeler or other person/entity, except in commercial applications defined below.

Original commercial purchaser: An "original commercial purchaser" is any person or entity, including but not limited to landlords, leasing companies, contractors, remodelers, and private or public businesses, who purchases the cabinetry for installation and use in any location that will be leased or used as a rental unit, or used for any other commercial or industrial application. The duration of this limited warranty is five years from the date of the product delivery to the location.

Proof of purchase is required. This limited warranty is expressly limited to repair or replacement of the cabinetry at the discretion of the manufacturer. This limited warranty does not include labor costs for removal, repairs, installation, or replacement.

This limited warranty does not cover defects, damage, or failure caused by improper handling, cleaning, installation, storage, assembly or disassembly, intentional damage, unauthorized product modifications and repairs, exposure to the elements including extreme humidity, moisture, or temperatures which may result in warping, splitting, or finish failure, accidental misuse, abuse, or negligence. Humidity levels in the home with cabinetry outside the range of 30-50% and temperature levels outside the range of 50-85°F are considered extreme.

Natural woods may vary in texture, color, and wood grain, and exhibit subtle changes as they age. For example, wood joints may develop visible cracking around the joint area and cabinet colors may darken or lighten over time.

Sunlight, smoke, moisture, household cleaners and other environmental conditions may cause materials to vary from their original color and/or

to warp, split or crack. These variations are considered to be the nature of the material in relation to its environmental exposure and are not covered under this limited warranty.

THE MANUFACTURER OF 1951 PROGRESSIONS CABINETRY MAKES NO OTHER WARRANTIES OTHER THAN THOSE SET FORTH HEREIN AND ALL OTHER WARRANTIES ARE HEREBY DISCLAIMED.

THE IMPLIED WARRANTIES OF MERCHANTABILITY AND FITNESS FOR A PARTICULAR PURPOSE ARE LIMITED IN DURATION TO THE LENGTH OF THE LIMITED WARRANTY PERIOD.

THE LIMITED WARRANTIES SET FORTH HEREIN ARE LIMITED TO THE FIRST AND ORIGINAL BUYER AND ARE NOT TRANSFERABLE THEREAFTER. PROOF OF PURCHASE IS REQUIRED TO DETERMINE ELIGIBILITY.

EXCEPT AS PROVIDED IN THIS LIMITED WARRANTY AND TO THE MAXIMUM EXTENT PERMITTED BY LAW, THE MANUFACTURER OF 1951 PROGRESSIONS CABINETRY SHALL NOT BE LIABLE FOR INCIDENTAL, DIRECT, INDIRECT, CONSEQUENTIAL, OR SPECIAL DAMAGES TO THE PURCHASER OR TO ANY THIRD PARTY RESULTING FROM ANY BREACH OF WARRANTY OR CONDITION, OR UNDER ANY OTHER LEGAL THEORY, INCLUDING BUT NOT LIMITED TO: LOSS OF USE, LOST PROFITS, LOSS OF BUSINESS OPPORTUNITY, LOSS OF PROPERTY, OR OTHER ECONOMIC LOSSES. THE FOREGOING LIMITATION SHALL NOT APPLY TO PERSONAL INJURY CLAIMS OR ANY STATUTORY LIABILITY FOR INTENTIONAL AND GROSS NEGLIGENT ACTS AND/OR OMISSIONS.

#### Additional Exclusions, Limitations and Disclaimers

This limited warranty limits the coverage period for the following components that were not manufactured by American Woodmark:

#### Range hood blowers and components – one year from the date of delivery

SOME STATES DO NOT ALLOW THE EXCLUSION OR LIMITATION OF INCIDENTAL OR CONSEQUENTIAL DAMAGES, OR LIMITATIONS ON HOW LONG AN IMPLIED WARRANTY LASTS, SO THE ABOVE LIMITATIONS AND EXCLUSIONS MAY NOT APPLY TO YOU.

THIS WARRANTY GIVES YOU SPECIFIC LEGAL RIGHTS, AND YOU MAY ALSO HAVE OTHER RIGHTS, WHICH VARY FROM STATE TO STATE.

### Claims

All claims under this limited warranty must be submitted to the manufacturer and must specify the defects present in the cabinets and accessories. Photos or samples of the product may be required to determine coverage.

After the manufacturer has had an opportunity to inspect the cabinets and/or accessories, it will, at its discretion, ship at no cost to the customer,

replacement cabinets and/or parts necessary for repair. Products may require chemical or function testing to determine resolution of a warranty claim. Replacement products are subject to availability and may differ from those originally supplied.

Submit all claims to 1951 Progressions at Post Office Box 1980, Winchester VA 22604, partners@woodmark.com, OR 877-957-7278.

## Continuous Improvement

In keeping with our policy of continuous product refinement, 1951 Progressions reserves the right to change specifications in design and materials as conditions require.



**Notes**



A series of horizontal lines for writing notes, consisting of 25 evenly spaced lines that fill the majority of the page.





## Service You've Come to Expect

Homeowners, contractors, and distributors all want value-priced cabinetry without compromising on service and support. With 1951 Progressions you'll get budget-friendly, high-quality cabinetry backed by the same level of service and support our customers have trusted from 1951 Cabinetry for seven decades.

## Unmatched Experience and Craftsmanship

For more than 70 years, we've cared about the end product as much as you and your customers do. That's why we proudly back every 1951 Progressions cabinet with a limited lifetime warranty. With an emphasis on quality, 1951 Progressions offers two door styles and three finishes, so homeowners can enjoy lasting beauty and value for years to come.





# 1951<sup>TM</sup>

**Progressions**

## Questions?

Contact the Partner Team.

We are here for you.

1-877-957-7278

Monday – Friday 8:00 AM – 7:00 PM EST

P.O. Box 1980

Winchester, Virginia 22604

[www.1951Cabinetry.com/Progressions](http://www.1951Cabinetry.com/Progressions)



Photography is for illustration purposes only. Actual colors may vary slightly due to the printing process. For actual color selections, please consult your 1951 Cabinetry representative. Every effort was made to ensure accuracy of the information contained herein at the time of printing; however, 1951 Cabinetry makes no representations to such accuracies. If you would like further clarification about any of our products or processes, please call the 1951 Cabinetry Partner Team.

51P SPEC GUIDE 3-25 ©2025 American Woodmark Corporation® and 1951 Cabinetry™ are registered trademarks of the American Woodmark Corporation.